

PHILIPS

VoiceTracer

Audio Recorder

DVT4110
DVT6110
DVT7110
DVT8110



User manual

Table of contents

| | | |
|----|--|----|
| 1 | Important | 3 |
| 2 | Your VoiceTracer audio recorder | 6 |
| | Product highlights | 6 |
| | What's in the box | 6 |
| | Overview of your audio recorder | 7 |
| 3 | Get started | 8 |
| | Charging the battery | 8 |
| | Turn the device on and off | 8 |
| | Key lock | 8 |
| | Connect to a computer | 9 |
| | Set the date and time | 9 |
| | Set the device language | 9 |
| 4 | Recording | 10 |
| | Record a file | 10 |
| | Edit a file | 10 |
| 5 | Playback | 11 |
| | Play back files | 11 |
| | Delete files | 11 |
| 6 | Settings | 12 |
| | Settings mode | 12 |
| | Recording settings | 12 |
| | Playback settings | 13 |
| | Device settings | 13 |
| 7 | Connect to VoiceTracer App | 14 |
| 8 | How to use the meeting microphone (DVT8110 only) | 15 |
| 9 | Connect to video camera (DVT7110 only) | 16 |
| 10 | Device and data management | 17 |
| | Transfer data to the computer | 17 |
| | Device reset | 17 |
| | Reset data | 18 |
| | Reset settings | 18 |
| | Updating your device | 18 |
| 11 | Troubleshooting | 20 |
| 12 | Technical data | 21 |

1 Important

Do not make any adjustments and modifications that are not described in this manual. Follow all safety instructions to ensure proper operation of the device. The manufacturer assumes no liability for damages resulting from non-compliance with the safety instructions.

Safety instructions

- Protect the device from rain and liquids to prevent damage to the device or a short circuit.
- Do not expose the device to excessive heat caused by placing it on a heating device or in direct sunlight.
- Protect the cables from damage by being trapped, particularly at the plugs and where cables exit the housing.
- Do not perform any maintenance operations that are not described in this user manual. Do not disassemble the device into its component parts to carry out repairs. The device may only be repaired in authorized service centers.
- All wireless devices may be susceptible to interference, which could affect performance.
- Back up your data and recordings. The manufacturer's warranty does not cover loss of data resulting from user actions.

Rechargeable built-in battery

- This device contains a built-in Li-polymer battery which should not be replaced by the customer. The battery may only be replaced in authorized service centers or by an authorized Philips partner for dictation equipment.
- Batteries contain substances that may pollute the environment. Used batteries should be disposed of at an official collection point.

Data reset

Philips VoiceTracer has an internal memory with 8 GB built-in storage. If you want to perform a factory data reset, observe the following cautions:

- Back up your data and recordings. Performing a factory data reset will delete all data on your device.
- Formatting the memory on a computer may cause incompatibilities with your device. Format the memory only on the device.

Hearing protection

Observe the following guidelines when you use headphones:

- Set the volume to a moderate level and don't use headphones to listen for excessively long periods of time.
- Be particularly careful to avoid adjusting the volume to a level that your hearing can't deal with.
- Don't turn the volume up so high that you can't hear what is going on around you.
- In potentially dangerous situations, be particularly careful or temporarily discontinue use.
- Don't use headphones while you are operating a motorized vehicle, cycling, skateboarding, and so on. You could be a hazard to yourself and other road users, and possibly be breaking the law.

Small children

Your device and its enhancements may contain small parts. Keep them out of the reach of small children.

Medical device interference

Operation of any radio transmitting equipment may interfere with the functionality of inadequately protected medical devices. Consult a physician or the manufacturer of the medical device to determine if they are adequately shielded from external RF energy or if you have any questions. Switch off your device in health care facilities when any regulations posted in these areas instruct you to do so. Hospitals or health care facilities may be using equipment that could be sensitive to external RF energy.

Implanted medical devices

VoiceTracer contains components that emit electromagnetic waves. Electromagnetic waves might interfere with the operation of implanted medical devices, such as pacemakers or implanted cardioverter defibrillators. Manufacturers of medical devices recommend that a minimum separation of 15.3 cm (6 inches) should be maintained between a wireless device and an implanted medical device to avoid potential interference with the medical device. Persons who have such devices should:

- Always keep the wireless device more than 15.3 cm (6 inches) from the medical device when the wireless device is turned on.
- Not carry the wireless device in a breast pocket.
- Turn the wireless device off immediately if there is any reason to suspect that interference is taking place.
- Read and follow the directions from the manufacturer of their implanted medical device.

If you have any questions about using your wireless device with an implanted medical device, consult your health care provider.

Hearing aids

Some digital wireless devices may interfere with some hearing aids. If interference occurs, consult your service provider.

Vehicles

RF signals may affect improperly installed or inadequately shielded electronic systems in motor vehicles such as electronic fuel injection systems, electronic antiskid (antilock) braking systems, electronic speed control systems, and air bag systems. For more information, check with the manufacturer, or its representative, of your vehicle or any equipment that has been added.

Only qualified personnel should service the device or install the device in a vehicle. Faulty installation or service may be dangerous and may invalidate any warranty that may apply to the device. Check regularly that all wireless device equipment in your vehicle is mounted and operating properly. Do not store or carry flammable liquids, gases, or explosive materials in the same compartment as the device, its parts, or enhancements. For vehicles equipped with an air bag, remember that air bags inflate with great force.

Use in aircraft

Wireless transmitters can negatively affect the operation of other electronic equipment, causing them to malfunction. Turn off your device when you travel in aircraft.

Legal restrictions on recording

- The use of the device's recording function is subject to the legal restrictions that may apply in your country. You should also respect the privacy and personal rights of third parties if you record talks or lectures.
- If you want to record telephone calls, check if this is legal in your country. In certain countries, you may be legally required to inform the person you are conversing with on the telephone that you are recording the conversation.

Cleaning and disinfection

- Before cleaning, disconnect all cables from the device.
- To clean the device, use a soft dry cloth.
- To disinfect the device, use products for disinfection of surfaces in clinical areas and patient care equipment, such as surface disinfectant wipes.
- Do not use harsh chemicals or strong detergents.
- Avoid getting moisture in openings.
- Do not rub or strike the surface with anything hard or sharp as this may scratch or damage the surface permanently.

Disposal of your old product

Europe

A crossed-out wheeled bin symbol attached to a product indicates that the product is covered by the European Directive 2011/65/EU. Please get informed about the local separate collection system for electrical and electronic products. Please act according to your local rules and don't dispose of your old products with your normal household waste. Correct disposal of your old product helps to prevent potential negative consequences for the environment and human health.



United States

Rechargeable Li-ion battery:

- Your product is designed and manufactured with high quality materials and components, which can be recycled and reused. For recycling information, please contact your local waste management facilities or visit www.recycle.philips.com.
- This appliance contains a rechargeable lithium-ion battery which must be disposed of properly.
- Contact your local town or city officials for battery disposal information. You can also call 1-800-822-8837 or visit www.call2recycle.org for battery drop-off locations.
- For assistance, visit our website www.philips.com/support or call 1-800-243-3050 toll free.

Rechargeable NiMH battery:

- Your product is designed and manufactured with high quality materials and components, which can be recycled and reused. For recycling information, please contact your local waste management facilities or visit www.recycle.philips.com.
- This appliance contains a rechargeable NiMH battery which must be disposed of properly.
- Contact your local town or city officials for battery disposal information.

You can also call 1-800-822-8837 or visit www.call2recycle.org for battery drop-off locations.

- For assistance, visit our website www.philips.com/support or call 1-800-243-3050 toll free.

Canada

Rechargeable Li-ion battery:

- Your product is designed and manufactured with high quality materials and components, which can be recycled and reused. For recycling information, please contact your local waste management facilities or visit www.recycle.philips.com.

- This appliance contains a rechargeable lithium-ion battery which must be disposed of properly.
- Contact your local town or city officials for battery disposal information.

You can also call 888-224-9764 or visit www.call2recycle.ca for battery drop-off locations.

- For assistance, visit our website www.philips.com/support or call 1-800-243-7884 toll free.

Rechargeable NiMH battery:

- Your product is designed and manufactured with high quality materials and components, which can be recycled and reused. For recycling information, please contact your local waste management facilities or visit www.recycle.philips.com.

- This appliance contains a rechargeable NiMH battery which must be disposed of properly.
- Contact your local town or city officials for battery disposal information.

- You can also call 888-224-9764 or visit www.call2recycle.ca for battery drop-off locations.

- For assistance, visit our website www.philips.com/support or call 1-800-243-7884 toll free.

About this user manual

Find a quick overview of your device on the next pages. For detailed description, see the following chapters of this user manual. Read the instructions carefully.

Symbols used



- This symbol identifies information that helps you to use your device more efficiently and simply.



- This symbol indicates notices which you should observe when handling or operating the device.



- This symbol warns of damage to the device and possible data loss. Damage can be caused by improper handling.

2 Your VoiceTracer audio recorder

We are delighted that you have chosen a Philips device. Visit our website for comprehensive support, such as user manuals, software downloads, warranty information and more: www.philips.com/dictation.

Product highlights

- Superior recording quality
- Audio scenes
- Voice-activated recording
- MP3 and PCM recording
- Large color display
- 8 GB internal memory
- Long-lasting battery

What's in the box

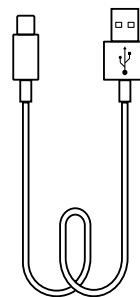
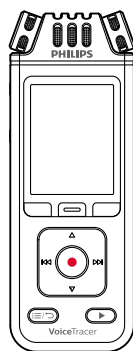

DVT7110

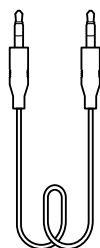

DVT7110

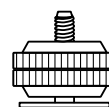

DVT7110

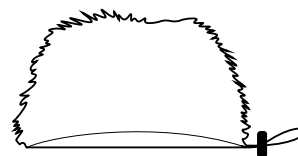

DVT8110

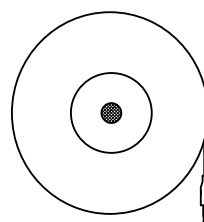

DVT8110

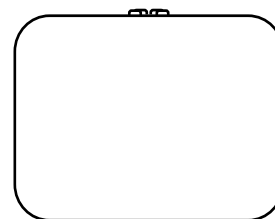

Overview of your audio recorder

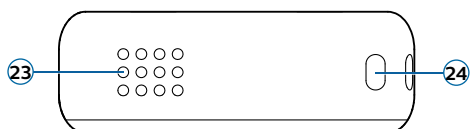
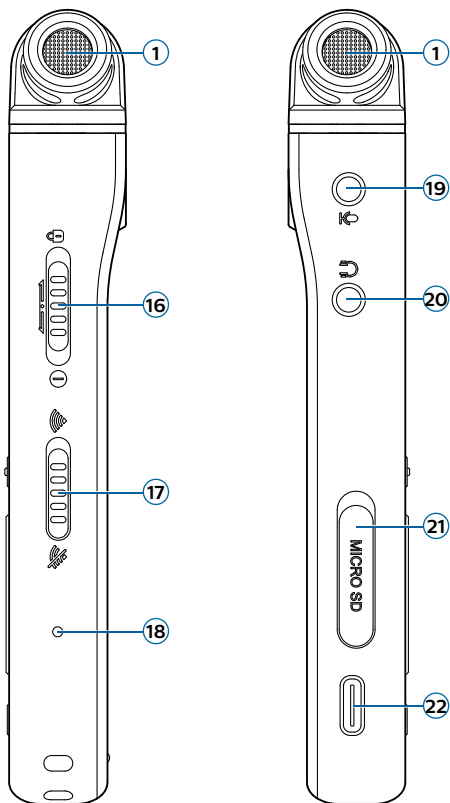
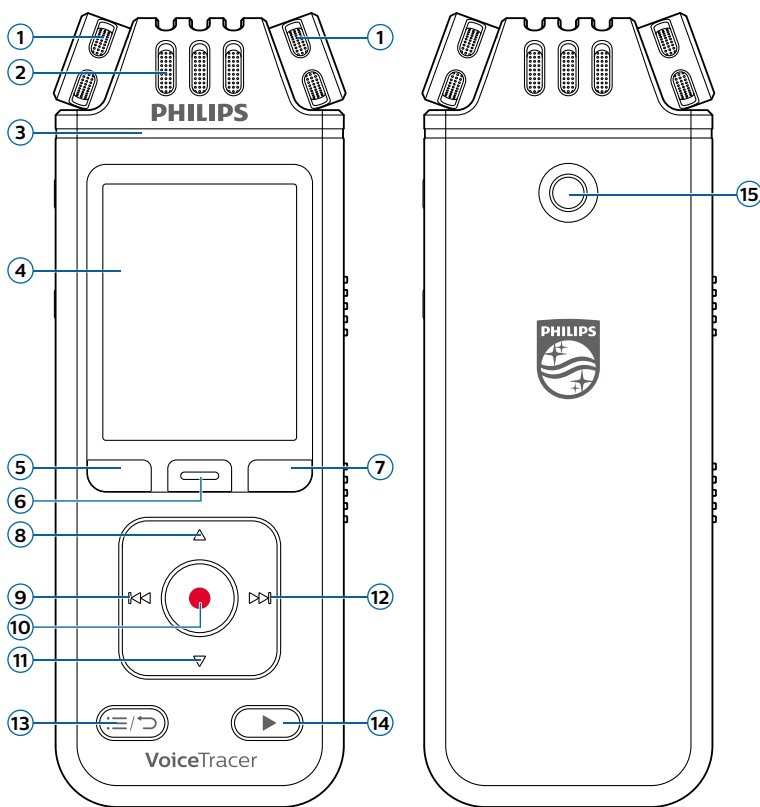

- ① 360° microphone
- ② Directional microphone
- ③ Record/Status LED
- ④ Display
- ⑤ Left function button
- ⑥ Middle function button
- ⑦ Right function button
- ⑧ Up button
- ⑨ Backward button
- ⑩ Record button
- ⑪ Down button
- ⑫ Forward button
- ⑬ File list/Back button
- ⑭ Play/Stop button
- ⑮ Tripod thread
- ⑯ Power/Lock switch
- ⑰ Wi-Fi on/off switch
- ⑱ Reset button
- ⑲ External microphone jack
- ⑳ Headphones jack
- ㉑ MicroSD card slot
- ㉒ USB Type-C port
- ㉓ Speaker
- ㉔ Eye for wrist strap

3 Get started

! Caution

- Before you connect your VoiceTracer, first read the safety instructions (see [Safety instructions](#)).

Charging the battery

Charge the built-in battery before you use the device for the first time or if you haven't used it for an extended time period. If the battery is completely discharged and your device turns off, allow the battery to charge for a while before you turn on the device.

☰ Note

- A complete charging cycle takes about 3 hours.
- Before you charge the battery via computer, make sure that your computer is turned on.
- While the device is connected to a computer, it can't be operated manually.
- When the low battery icon  is displayed, charge the device promptly.
- If you charge your device via computer instead of using a power supply unit, the charging speed might slow down due to a lower charging current. For fast charging, use a USB power supply unit (not included).

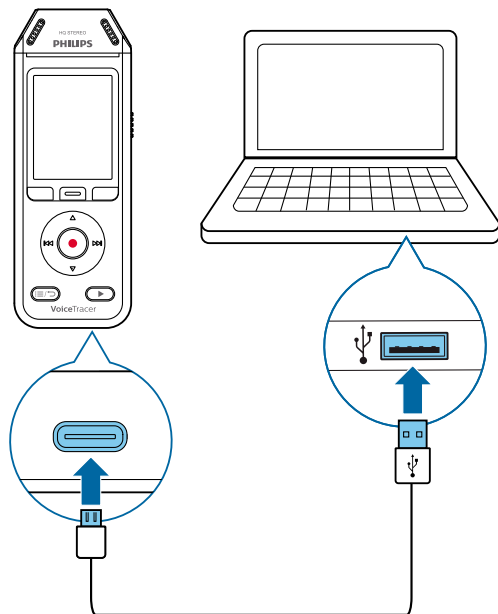

- ↳ A charging battery icon appears on the screen and the Record/Status LED flashes orange for a few seconds.

Turn the device on and off

To turn the device on or off:

- Slide and hold the Power switch on the right side of the device downwards for three seconds.

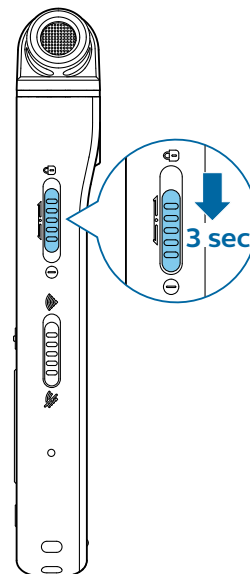

Key lock

You can lock your device when it's active to prevent any unwanted device operations or access.

To lock the device:

- Slide the Power switch on the right side of the device upwards towards the lock symbol.
 - ↳ The lock symbol appears on the screen for a moment.
 - ↳ All buttons are locked now.

To unlock the device:

- Slide the Power switch downwards.
 - ↳ The unlock symbol appears on the screen for a moment.

Connect to a computer

You can use your recorder as a USB mass storage to conveniently store, back up and move files. Link the device to a computer with a USB cable. Your recorder will automatically be recognized as a mass storage device. You don't need to install any software.

For more information on how to connect your device to a computer, see the illustration in [Charging the battery](#).

Caution

- Don't disconnect the USB cable from the device while you are transferring files. This might cause data loss.

Note

- While the device is connected to a computer, it can't be operated manually.

Set the date and time

You can always change the date and time as well as the time format on your device.

- 1 In stop mode, press the Right function button  to open the settings panel.
- 2 Press the Record button to select **All settings**.
- 3 Press the Right function button to enter the Device settings.
- 4 Press the Down button to navigate to **Date & time** and then press the Record button to confirm.
- 5 Press the Up/Down buttons to navigate to your desired setting **Date**, **Date format**, and **Time**. Use the Forward and Backward buttons to change your desired setting.
- 6 Press the Record button to confirm your settings.
- 7 Press the Back button to return to the stop mode screen.

Set the device language

You can always change the language of your device.

- 1 In stop mode, press the Right function button  to open the settings panel.
- 2 Press the Record button to select **All settings**.
- 3 Press the Right function button to enter the Device settings.
- 4 Press the Record button to select **Language**.
- 5 Press the Up/Down buttons to navigate to your desired language, and then press the Record button to confirm your selection.
- 6 Press the Back button to return to the stop mode screen.

4 Recording

Record a file





Note

- Be careful not to cover the microphones while recording. This might result in a lower recording quality.
- If the recording time of your current recording exceeds the available storage capacity, the recording will stop. In this case, delete files from your device to make more storage available.

Before you start recording:

- Make sure your device has enough battery power left. When your battery is almost discharged, you will see a battery low icon .
 - ↳ The device will turn off and your current recording will automatically be saved.
- First select the folder you want your recording to be saved in. For more information, see [Start a new recording](#). You can store 100 files in each of the folders A, B, C, and D. If one of the folders is full, your subsequent recordings will automatically be stored in the next folder.
- We recommend that you make a test recording in order to find the most suitable presets for your recording and achieve the best recording results.

Start a new recording

- 1 In stop mode, press the Left function button  to start a new recording.
 - ↳ The new file mode screen is displayed.
- 2 Press the Right function button to open the settings panel .

To select a folder for your recording to be saved in.

- Press the Up/Down buttons to navigate to **Folder** and then press the Record button to confirm your selection.
Press the Up/Down buttons to navigate to the folder you want your new recording to be saved in and then press the Record button to confirm your selection..
To return to the stop mode screen, press the Back button.

To adjust the settings for your recording:

- Press the Up/Down buttons to navigate to your desired setting and then press the Record button to confirm your selection.
To return to the stop mode screen, press the Back button.

- 3 Press the Record button to start recording.
 - ↳ The recording screen is displayed.
 - ↳ The Record/Status LED illuminates red.
- 4 Press the Record button again to stop recording.
 - ↳ The recording is saved to the preselected folder.

Edit a file

You can edit existing recordings in stop mode by appending or overwriting a recording.

Append: Add additional recording parts at the end of an existing recording.

Overwrite: Overwrite an existing recording part starting from any point within the recording.

To append a recording part:

In stop mode of an existing file, press the Record button.

- If the cursor of the audio progress bar is at the end of the recording:
 - ↳ The recording screen is displayed and a new recording part is added at the end of your file.
- If the cursor of the audio progress bar is at the beginning of the recording:
 - ↳ The editing panel opens.
 - ↳ Press the Up/Down buttons to select **Append** and then press the Record button to confirm your selection.
 - ↳ The recording screen is displayed and a new recording part is added at the end of your file.

To overwrite a recording part:

- 1 In playback mode, press the Play/Stop button to stop playback at your desired part.
- 2 Press the Record button.
 - ↳ The editing panel opens.
- 3 Press the Up/Down buttons to select **Overwrite** and then press the Record button to confirm your selection.
 - ↳ The recording screen is displayed and a new recording starts from where you stopped playback.



Tip

- If you always want to either append or overwrite a recording part and don't want the editing panel to open each time, press the Right function button to open the settings panel . Press the Down button to navigate to **Edit mode** and then select **Append** or **Overwrite**.

5 Playback

Play back files



Note

- If you have connected headphones to your VoiceTracer, the built-in speakers are disabled.

Start and stop playback

- 1 In stop mode, press the Previous track or Next track button to navigate to your desired recording.
To start playback, press the Play/Stop button.
↳ The Record/Play indicator illuminates green.

Alternatively, press the File list button and then press the Up/Down buttons to navigate to your desired recording.

To start playback, press the Play/Stop button.

- 2 To adjust the volume, press the Up/Down buttons.
- 3 To stop playback, press the Play/Stop button.
- 4 To continue playback, press the Play/Stop button again.

Fast rewind or fast forward

- In playback mode or stop mode, press and hold the Backward or Forward button to jump to the desired part of the recording. Release the switch when you have reached your desired playback part.



Note

- If you have set bookmarks and press the Backward or Forward button shortly, the audio progress indicator will jump to the next or previous bookmark. If you have not set bookmarks and press the Backward or Forward button shortly, you will jump to the previous or next file.

Play back files from a selected folder

- 1 In stop mode, press the File list button.
↳ All voice recordings are displayed.
- 2 Press the Left function button  to open the folder panel.
- 3 Press the Up/Down buttons to navigate to your desired folder and then press the Record button to confirm your selection.
↳ Only the files in the selected folder are displayed now.

Delete files

You can delete individual files from your device.

- 1 In stop mode or playback mode, press the Right function button  to open the settings panel.
- 2 Press the Up/Down buttons to navigate to **Delete** and then press the Record button to confirm your selection.



Tip

- If you would like to delete several files at once, use the VoiceTracer app. For more information, see [Connect to VoiceTracer App](#).

6 Settings

Settings mode

In the settings mode, you can change and adjust various settings according to your own preferences.

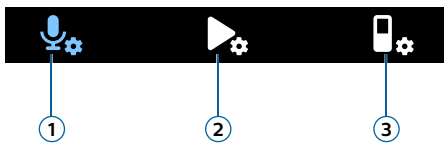

- ① Recording settings
- ② Playback settings
- ③ Device settings

Start the settings mode

- 1 In stop mode, press the Right function button to open the settings panel.
- 2 Press the Record button to select **All settings**.

Navigate between settings

- Use the Up/Down buttons.

Select a setting

- Press the Record button.

Recording settings



Scene

Select a scene according to specific recording situations, e.g. a lecture or an interview. Every scene has pre-defined settings, such as the format or the microphone sensitivity, that cannot be changed. If you would like to change the settings of a scene, you need to select the scene Custom where you can define each setting according to your own preferences.

Format

Select the format of your recording according to specific recording situations.

Mic sensitivity

Adjust the microphone sensitivity of your VoiceTracer. Select the sensitivity according to the background noise, number of recorded sound sources and distance between sound source and microphones.

Limiter

Activate this function to prevent recordings from being oversteered by sound input over the maximum sound level. If the recording suddenly exceeds the maximum sound level, the microphone sensitivity is automatically reduced.

Mic selection

Select if the zoom mic or the 360 degrees microphones should be used for your recordings.

Noise cut

Turn the Noise cut feature on in order to reduce background noise while recording. This way, especially audio recordings sound clearer.

Wind filter

Activate the wind filter to reduce wind noise when you are recording in a very windy environment.

Folder

Select the folder you want your recording to be saved in.

Voice activation

Use voice activation to start recording when you begin speaking. When you stop speaking, the device will automatically pause recording after three seconds of silence. It will resume only when you begin speaking again.

Edit mode

Select what should happen when you edit a recording.

Pre-recording

When the pre-recording function is enabled, the device will start recording some seconds prior to the event.

Timer

Use the timer function to automatically start recording on a preset date and at a preset time. You can also select when the recording should stop.

Auto divide

During recording, the auto divide feature will automatically split the current recording and save a new file every 15, 30 or 60 minutes.

Auto bookmark

Use the Auto bookmark funktion to automatically set bookmarks at preset time intervals.

External input

Choose between various input sources to guarantee the best recording quality for specific recording situations.

Playback settings



Play mode

Choose between various playback options.

Equalizer

Choose between the equalizer music options Classical, Jazz, Pop, or Rock.

ClearVoice

Activate the ClearVoice function for better playback quality. Dynamic emphasis on quiet passages improves the intelligibility of quiet voices.

Device settings



Language

Select your desired device language from the language list. You can change the language whenever you want.

Brightness

Adjust the brightness of your screen according to your own requirements.

Backlight

To save your VoiceTracer's battery power, you can reduce the backlight time. If you don't operate your device for the preset time, the backlight turns off automatically.

Date & time

You can always change the system date and time on your device. Use the Backward, Forward, Up, and Down buttons to set the date and time.

Recording light

If you turn on the recording light, the Record/Status LED will illuminate red when recording.

Auto Off

Select a time for your device to automatically turn off when you don't operate it.

Device sounds

Select if you want the device sounds, such as key tone and power on/off sound, to be turned on or off.

Select storage

Select if you want your recordings to be saved on the device's internal storage or on the external memory card.

Format storage

Use this function to format your device's internal storage or the memory card and delete all data. For more information, see [Reset data](#).

Reset settings

You can reset your menu settings to their default state—the way they were when you first purchased your device and turned it on. For more information, see [Reset settings](#).

Information

See various information about your device, such as the available memory space or the firmware version.

7 Connect to VoiceTracer App

You can connect your VoiceTracer to the dedicated Philips VoiceTracer App via Wi-Fi. This allows you to remotely control your VoiceTracer with your smartphone. In addition, you can easily and conveniently transfer recordings from your VoiceTracer to the app and then share and forward your recordings immediately from your smartphone.

To connect your VoiceTracer to the app:

- 1 Download the Philips VoiceTracer App from the Google Play Store or the Apple App Store on your smartphone.
- 2 Once the app is downloaded, open it on your smartphone.



- 3 When using the app for the first time, a registration screen is displayed. You need to register by entering your first name, last name and an email address.
 - ↳ An instruction screen is displayed.
 - ↳ Follow the on-screen instructions precisely and follow each step in the displayed order.

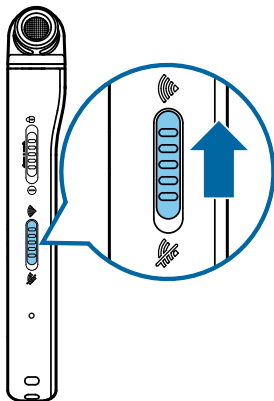

Note

- Make sure your VoiceTracer is turned on before activating the Wi-Fi switch. The Wi-Fi switch is on the right side of your VoiceTracer.

- 4 When the VoiceTracer starts scanning for available Wi-Fi networks, select your smartphone's hotspot by using the Up/Down buttons and then confirm with the Record button.
 - ↳ On the VoiceTracer screen, the password dialog is displayed.
- 5 On the password dialog screen of your VoiceTracer, enter the Wi-Fi password of your smartphone's hotspot by using the function buttons, the Up, Down, Backward, and Forward buttons.
 - ↳ Your VoiceTracer is now connected to the VoiceTracer App on your smartphone and the Wi-Fi symbol is displayed on your VoiceTracer screen.

8 How to use the meeting microphone (DVT8110 only)

The meeting microphone can be used during a meeting or a multi-participant conference. For optimum sound quality, the participants should not be more than two meters away from the microphone.

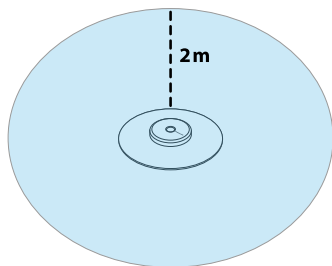

- 1 Stop the recording currently in progress.
- 2 Insert the microphone connector into the microphone jack on the left side of the VoiceTracer. Make sure that the external input source is set to **Line-in** in the recording settings (for more information, see [External input](#)).

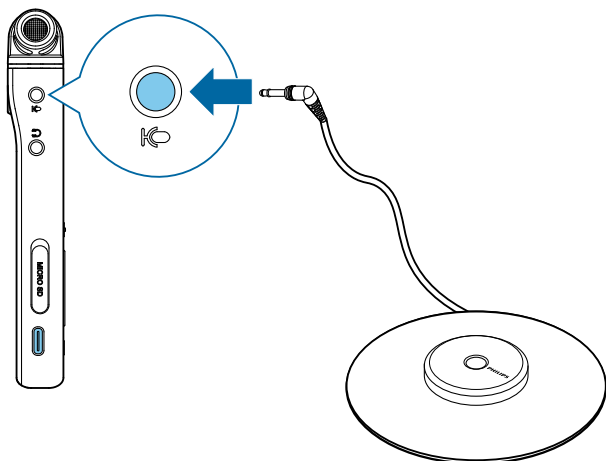

- 3 Start recording.



Tip

- If a recording is to be made in larger rooms or at meetings with a larger number of participants, the recording range may be extended by connecting up to a maximum of three meeting microphones.

9 Connect to video camera (DVT7110 only)

You can use your VoiceTracer as an external microphone for a video or DSLR camera. This ensures the best audio quality for your videos.

To connect your VoiceTracer to your video camera:

- 1 Screw the hot shoe adapter into the tripod thread on the back of your VoiceTracer.

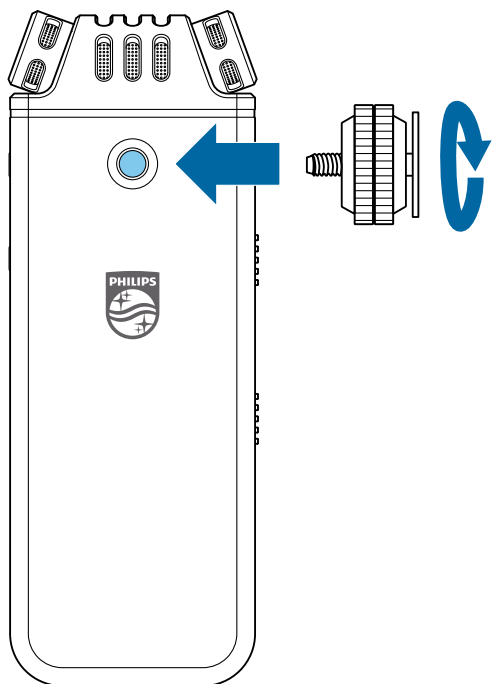

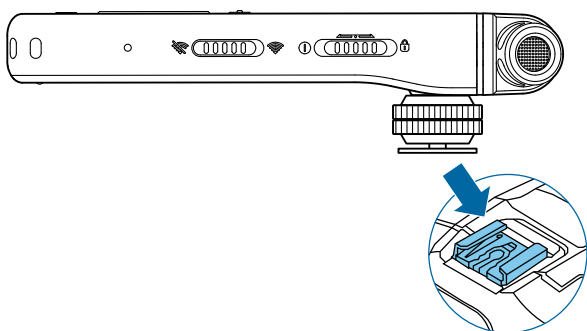

- 2 Slip the hot shoe adapter into your camera's hot shoe. Make sure to direct the front of your VoiceTracer in the direction you want to record.

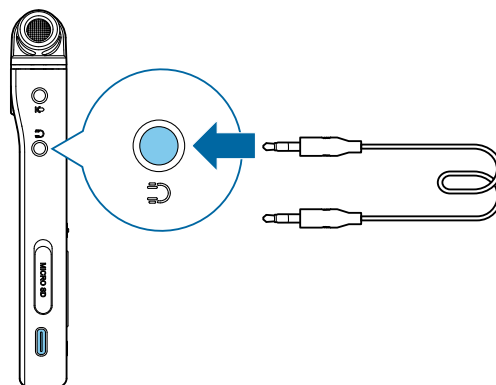

- 3 Use both adjusting screws on the hot shoe adapter to ensure that your VoiceTracer is fixated on your video camera / DSLR camera.

- 4 Insert the audio cable into the headphones jack on the left side of your VoiceTracer.



- 5 Insert the other end of the audio cable into the external microphone jack of your video camera.
- 6 In stop mode, press the Right function button  to open the settings panel. Select **Scene** and press the Record button, then select **Video** from the list and confirm with the Record button.
 - ↳ The Video scene main screen is displayed in red. You can also see the current audio levels for both channels on the bottom half of the screen.
- 7 Start recording the video on your video camera / DSLR camera.

Note

- In the Video scene the VoiceTracer operates as an external microphone, this means audio is not stored on your VoiceTracer. The audio is recorded and stored on your video camera / DSLR camera.

- 8 To exit the Video scene, press the Left function button.

10 Device and data management

Transfer data to the computer

You can quickly and conveniently move files from your VoiceTracer to your computer. Link the device to a computer with a USB cable. Your recorder will automatically be recognized as a mass storage device. You don't need to install any software.

For more information on how to connect your device to a computer, see the illustration in [Charging the battery](#).

! Caution

- Don't disconnect the USB cable from the device while you are transferring files. This might cause data loss.

☰ Note

- While the device is connected to a computer, it can't be operated manually.

Transfer data from VoiceTracer to the computer

- 1 Connect the device to the computer via the supplied USB cable.
 - ↳ A charging battery icon appears on the screen and the Record/Status LED flashes orange for a few seconds.
- 2 Open Windows Explorer on a Windows computer, or open Finder on a Mac computer.
 - ↳ Your VoiceTracer is recognized as an external drive.
- 3 Double-click the VoiceTracer drive.
 - ↳ The content of your VoiceTracer is displayed in a new window.
- 4 Select the desired files from one of the folders and copy, cut or drag them to the desired location on your computer.

Reset your device and data

Device reset

If you should encounter problems with your device software, for example, the software freezes, the device works slowly or apps don't respond, you can reset your device and restart it.

- 1 Press and hold the reset button on the right side of your device by using a small, pointed object, for example, a paper clip.

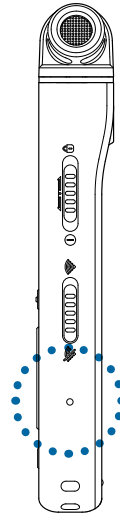

- 2 To restart the device, slide and hold the Power switch on the right side of the device downwards for three seconds.

Reset data

You can format your device's internal storage and delete all data from your device.



Caution

- Formatting your VoiceTracer will delete all data on your device. Before you perform a data reset, back up any important data saved on your device.



Note

- Your menu settings won't be deleted and are still available after resetting the data.

To reset your data:

- 1 In stop mode, press the Right function button  to open the settings panel.
- 2 Press the Record button to select **All settings**.
- 3 Press the Right function button to enter the Device settings.
- 4 Use the Up/Down buttons to navigate to **Format storage** and then press the Record button to confirm your selection.
- 5 Select if you would like to reset the data on the internal storage or on the memory card, and then press the Record button to confirm your selection.
- 6 Select **Delete**.
 - ↳ All data is deleted from the selected storage.

Reset settings

You can reset your menu settings to their default state—the way they were when you first purchased your device and turned it on.



Caution

- Resetting your menu settings will delete all settings you have made on your device. After a reset, you will have to adjust all settings again.



Note

- Your data won't be deleted and is still available after resetting the menu settings.

To reset your settings:

- 1 In stop mode, press the Right function button  to open the settings panel.
- 2 Press the Record button to select **All settings**.

- 3 Press the Right function button to enter the Device settings.
- 4 Use the Up/Down buttons to navigate to **Reset settings** and then press the Record button to confirm your selection.
- 5 Select **Reset**.
 - ↳ All settings on your device are reset to their default state.

Updating your device

Your device is controlled by an internal program called firmware. As a part of ongoing product maintenance, the firmware is upgraded and errors are corrected.

It is possible that a newer version (an 'update') of the firmware has been released since you purchased the device. In this case, you can easily update your device to the latest version.



Caution

- Before you update the firmware, make sure that your device has at least 30% battery power left. This helps to prevent the power supply being interrupted during the update.
- Don't disconnect the USB cable from the device while you are transferring files. This might cause data loss.



Note

- To find out about new firmware versions, regularly check the product website for your model at www.voicetracer.com/help.

Update your VoiceTracer

- 1 Connect the device to the computer via the supplied USB cable.
 - ↳ A charging battery icon appears on the screen and the Record/Status LED flashes orange for a few seconds.
- 2 Download the firmware update file for your model from the product website www.voicetracer.com/help.
- 3 Open Windows Explorer on a Windows computer, or open Finder on a Mac computer.
- 4 Double-click the VoiceTracer drive.
 - ↳ The content of your VoiceTracer is displayed in a new window.
- 5 Copy the firmware update file to the root directory of the device.
 - ↳ During this process, the Record/Status LED flashes orange. When the process is complete, the Record/Status LED stops flashing.

- 6 Disconnect the device from the computer.
 - ↳ The firmware is automatically updated.
 - ↳ The **Firmware update** window is displayed.
When the update is complete, the device will automatically switch off.

11 Troubleshooting

Find the most common problems you could encounter with the VoiceTracer in the following table. If you are unable to solve the problem with the information below, contact the supporting Philips partner you purchased the device from.

| Problem | Cause | Solution |
|---|---|--|
| The device doesn't turn on. | <ul style="list-style-type: none">• The battery has run out of power. | <ul style="list-style-type: none">• Charge the device for a while and then turn it on again. |
| I can't record with the device. | <ul style="list-style-type: none">• You have reached the maximum file number or the device's memory is full. | <ul style="list-style-type: none">• Delete some files or move them to an external device. |
| The device doesn't respond. | <ul style="list-style-type: none">• There is a problem with the software. | <ul style="list-style-type: none">• Try to turn the device off and then restart it.• If you can't turn the device off, reset the device by pressing the Reset button. For more information, see Device reset. Resetting the device won't delete any settings or data. |
| The device doesn't play back recordings. | <ul style="list-style-type: none">• The volume is off or too low. | <ul style="list-style-type: none">• Turn on or turn up the volume. |
| I can't hear anything from the speakers. | <ul style="list-style-type: none">• The headphones are connected to the device.• The volume is off or too low. | <ul style="list-style-type: none">• Unplug the headphones.• Turn on or turn up the volume. |
| I can't hear anything from the headphones. | <ul style="list-style-type: none">• The volume is off or too low.• The headphones aren't connected properly.• The headphones are connected to the wrong jack (i.e. external microphone jack). | <ul style="list-style-type: none">• Turn on or turn up the volume.• Disconnect the headphones and connect them to the headphones jack again.• Disconnect the headphones and connect them to the headphones jack. |
| The quality of audio recordings is too low or there's too much background noise in my audio recordings. | <ul style="list-style-type: none">• The microphone sensitivity is set too high. | <ul style="list-style-type: none">• Change the microphone sensitivity to medium or low. For more information, see Mic sensitivity. |

12 Technical data

Connectivity

- Headphones: stereo jack, 3.5 mm, impedance 16 Ohm or more
- Microphone: stereo jack, 3.5 mm, impedance 2 kOhm
- USB: type C, high-speed 2.0

Wireless connectivity

- Free remote control and sharing app
- Supported operating systems: Android 9/8/7/6, iOS 12/11
- Wi-Fi communication mode: personal/mobile hotspot on smartphone (tethering)
- Wi-Fi standard: IEEE 802.11 b/g/n/e/i (2.4 GHz only)
- Wi-Fi security: WPA/WPA2-PSK, WPS

Audio recording

- Built-in microphone: 2 omni-directional microphones, 1 directional microphone for distance zoom recording
- Recording formats: MPEG1 layer 3 (MP3), PCM (WAV)
- Recording quality: MP3 (8, 32, 64, 96, 128, 192, 256, 320 kbps), PCM (22 kHz/16 bit, 44.1/16 bit, 48 kHz/16 bit), DVT6110-8110: PCM (96 kHz/24 bit)
- Audio scenes: Note, Speech recognition, Interview, Lecture, Meeting, Music, Video, Custom
- Recording time (built-in memory): 2147 h (MP3, 8 kbps), 536 h (MP3, 32 kbps), 268 h (MP3, 64 kbps), 178 h (MP3, 96 kbps), 134 h (MP3, 128 kbps), 89 h (MP3, 192 kbps), 67 h (MP3, 256 kbps), 53 h (MP3, 320 kbps), 24 h (PCM, 22 kHz/16 bit), 12 h (PCM, 44.1 kHz/16 bit), 11 h (PCM, 48 kHz/16 bit), DVT6110-8110: 3 h (PCM, 96 kHz/24 bit)
- Pre-recording mode: 5, 10, 15 seconds buffer
- File editing function: overwrite, append
- Auto-divide function: 15, 30, 60 minutes
- Auto-bookmark function: 5, 10, 15, 30, 60 minutes
- Bookmark function: up to 32 per file
- Voice-activated recording: 25 levels
- Instant one-touch recording
- Record monitor function
- Recording timer
- Wind filter
- Limiter (attack time/decay time): slow (32/128 ms), medium (16/64 ms), fast (8/16 ms)
- Noise-cut

Speaker

- Speaker output power: 200 mW
- Speaker size: 11 × 15 mm

Storage media

- Built-in memory capacity: 8 GB
- Mass storage class compliant
- MicroSD card socket: up to 32 GB

Music playback

- Sound enhancement: ClearVoice
- Equalizer: Classic, Jazz, Pop, Rock
- Playback mode: Repeat file, Repeat all, Random
- ID3 tag support
- Supported file formats: MP3, WMA

Power

- Battery type: built-in rechargeable Li-ion polymer battery
- Battery lifetime: up to 36 hours of recording (MP3, 8 kbps)
- Battery capacity: 1000 mAh
- Rechargeable: yes
- Charging time (full charge): 3 hours

Design and finishing

- Color(s): silver/chrome (DVT4110)
anthracite/chrome (DVT6110-8110)

Display

- Type: LCD color display
- Backlight
- Diagonal screen size: 2 in/5 cm
- Resolution: 240 × 320 pixels

Product dimensions

- 4.7 × 12.9 × 1.9 cm / 1.8 × 5.1 × 0.8 in
- Weight: 93 g/ 3.3 oz.

Convenience

- Metallic tripod thread
- Firmware upgradeable
- Keypad lock
- Multi language: English, French, German, Spanish, Italian, Russian, Polish

System requirements

- Free USB port
- Operating system: Windows 10/8/7, macOS, Linux

Green specifications

- Compliant to 2011/65/EU (RoHS)
- Lead-free soldered product

Operation conditions

- Temperature: 1° – 45° C / 34° – 113° F
- Humidity: 10% – 90%

Open source software

Products mentioned in this manual may contain open source software.

Speech Processing Solutions GmbH hereby offers to deliver, upon request, a copy of the complete corresponding source code for the copyrighted open source software packages used in this product for which such offer is requested by the respective licenses. This offer is valid up to three years after product purchase. To obtain the source code, please write in English to: info@speech.com.

FCC Warning Statement



Changes or modifications not expressly approved by the party responsible for compliance could void the user's authority to operate the equipment.

This equipment has been tested and found to comply with the limits for a Class B digital device, pursuant to Part 15 of the FCC Rules. These limits are designed to provide reasonable protection against harmful interference in a residential installation. This equipment generates uses and can radiate radio frequency energy and, if not installed and used in accordance with the instructions, may cause harmful interference to radio communications. However, there is no guarantee that interference will not occur in a particular installation. If this equipment does cause harmful interference to radio or television reception, which can be determined by turning the equipment off and on, the user is encouraged to try to correct the interference by one or more of the following measures:

- Reorient or relocate the receiving antenna.
- Increase the separation between the equipment and receiver.
- Connect the equipment into an outlet on a circuit different from that to which the receiver is connected
- Consult the dealer or an experienced radio/TV technician for help.



Neither Speech Processing Solutions GmbH nor its affiliates shall be liable to the purchaser of this product or third parties with respect to claims for damages, losses, costs or expenses incurred by purchaser or third parties as a result of an accident, misuse or abuse of this product or unauthorized modifications, repair, modification of the product or failure to meet the operating and maintenance instructions provided by the manufacturer.

This user manual is a document with no contractual nature. We accept no liability for changes, mistakes or printing errors.



Issue date 2019-10-04
Version 1.1

© 2019 Speech Processing Solutions GmbH. All rights reserved.

Specifications are subject to change without notice. Philips and the Philips shield emblem are registered trademarks of Koninklijke Philips N.V. and are used by Speech Processing Solutions GmbH under license from Koninklijke Philips N.V. All trademarks are the property of their respective owners.

www.philips.com/dictation